

# Installation

# Typical Installations

## How To Plan Your Chimney Installation

Step 1.	Measure the diameter of the appliance flue outlet. Select the chimney and either DVL or DuraBlack connector stovepipe with the same size diameter as the appliance flue outlet.
Step 2.	Measure the roof pitch. For example, a 6/12 pitch has a vertical rise of 6" over a horizontal distance of 12". Select the appropriate flashing.
Step 3.	Determine the minimum chimney height above the roof line. Building codes require a minimum of 3' above the roof penetration, and at least 2' higher than any portion of a building within 10'. See Figure 1.
Step 4.	If an offset is required to avoid rafters or other obstructions, measure the horizontal distance required and the vertical height available. Both 15° and 30° elbows are available. Please note that 45° elbows are not allowed in the United States. At least one Elbow Strap is required for each offset. Elbow Straps ensure adequate support.
Step 5.	Determine the total length of chimney and stovepipe required for the installation. To calculate the installed per length of 6"-8" DuraPlus chimney pipe, subtract 1 1/2" per joint. Subtract 1 1/4" per joint of DuraBlack stovepipe. Subtract 1 1/2" per joint of DVL stovepipe. Minimum chimney height, at sea level of straight vertical chimney is 10' to 15' above the appliance outlet. Higher elevations, or the use of elbows or a tee, will require approximately 30% to 60% more height to provide for an adequate draft.

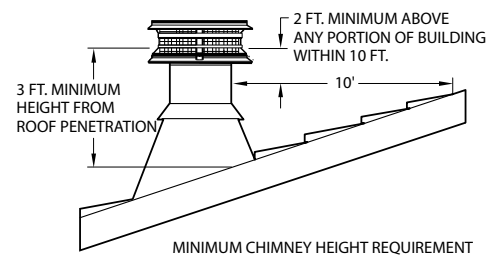
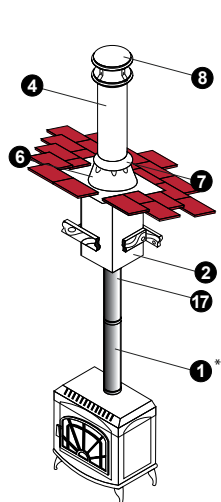
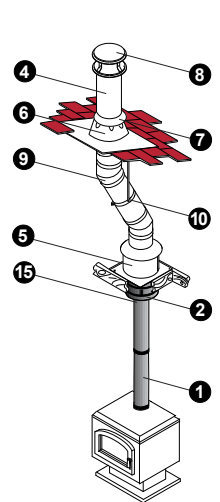

Figure 1



Manufactured Home  
\*DVL stovepipe required for this installation



Attic Offset

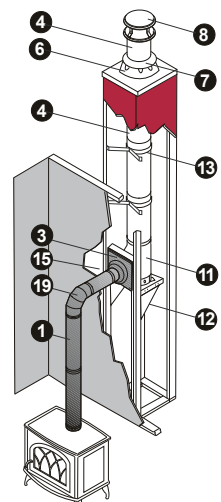

Through-the-Wall

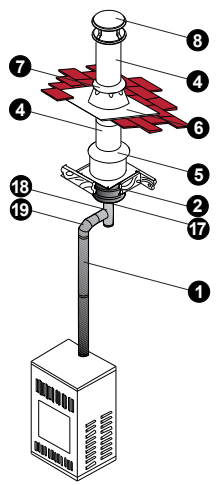

Oil Furnace

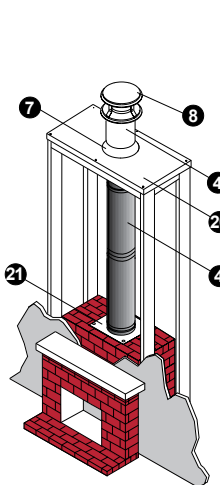

Fireplace  
(new or retrofit)

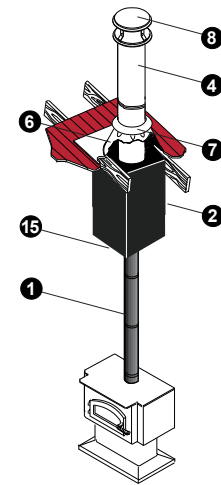

Cathedral Ceiling  
Roof Support

DuraPlus	
1	DVL or DuraBlack Stovepipe
2	Ceiling Support Box
3	Wall Thimble
4	DuraPlus Chimney
5	Attic Insulation Shield
6	Roof Flashing
7	Storm Collar
8	Chimney Cap
9	Elbow
10	Elbow Strap
11	Tee with Cap
12	Tee Support Bracket
13	Wall Strap
14	Firestop Radiation Shield
15	Snap-Lock Adapter, DVL/ DuraBlack Chimney Adapter, DuraBlack Slip Connector
16	Extended Roof Bracket
17	DVL or DuraBlack Chimney Adapter
18	DVL or DuraBlack Tee
19	DVL or DuraBlack Elbow
20	Chase Top Flashing
21	Anchor Plate

- A DVL/DuraBlack Chimney Adapter or DuraBlack Slip Connector must be used when connecting DVL or DuraBlack stovepipe to a Ceiling Support or Wall Thimble. A Snap-Lock Adapter must be used when attaching snap-lock stovepipe to DuraPlus.
- A Wall Thimble must be installed with an appropriate section of chimney pipe for all horizontal through-the-wall installations. To accommodate thicker walls a wall thimble extension can be field fabricated.
- An Attic Insulation Shield must be used in all installations that pass through an attic, regardless of whether the attic is insulated or not. If chimney is enclosed in a chase in the attic space, an Attic Insulation Shield is not required.
- A Firestop Radiation Shield must be used when a chimney passes through a floor or ceiling without a Ceiling Support Box.

## How It Works

The chimney system allows your stove or fireplace to exhaust flue gases while a draft creates the draw that pulls fresh combustion air into the stove. A well balanced system provides an even, hot fire when it has good draft. The draft suction keeps smoke from coming into the room. Insulation in the chimney pipe is important because it helps keep the exhaust hot until it is expelled outside. Heat in the chimney makes draft, which pulls in more combustion air. This creates a hotter fire, delivering more heat to the chimney and resulting in more draft. The size of the flue is important for the system to work efficiently. The appliance manufacturers installation instructions will indicate how to size the flue to match the stoves flue collar.

Stovepipe connects to the stove. It is the usually black interior pipe that transitions from the stove to the chimney pipe with an adapter. It is not insulated and cannot penetrate ceilings or walls. Chimney pipe is an insulated pipe that is rated to pass through walls and ceilings. In addition to the chimney pipe, supports to hold the system in place and shields to protect areas from combusting are needed for the system. The flashing, storm collar and chimney cap are required to seal the system from moisture penetration.

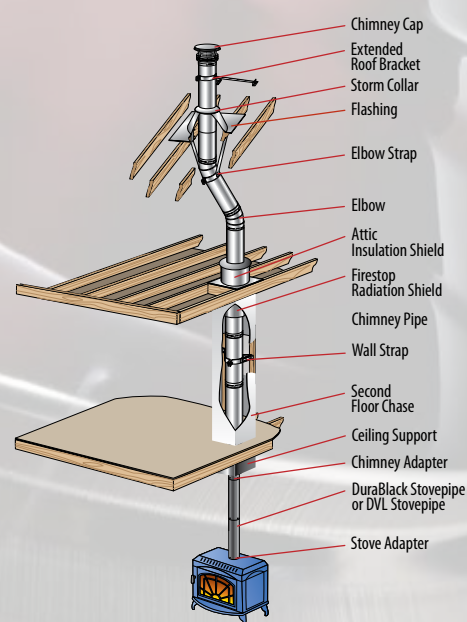

# Contact

## Professional Technical Help

DuraVent prides itself on providing the best customer service and technical support in the industry.

Our Customer Support Team is available to answer technical questions.

Monday – Friday  
5:30am – 4pm PST | 8:30am – 7pm EST

Tel: 800-835-4429  
Fax: 707-446-4740  
customerservice@duravent.com



DuraPlus®  
All-fuel, triple-wall  
chimney system.  
UL 103 HT.

# DuraPlus®



## Applications

DuraPlus Chimney is a triple-wall, all-fuel chimney for use with wood stoves, fireplaces, furnaces, boilers, stoves, ranges, water heaters, or other appliances fueled by wood, oil, coal, or gas.

## Materials and Construction

.016" 430 stainless steel outer wall or .018" galvanized steel outer wall.

.018" aluminized steel intermediate liner.

.016" 430 stainless steel inner liner.

Insulated layers of ceramic blanket plus ventilated air space. Locks tightly with a precision twist-lock connection.

## Clearances

2" clearance to combustibles.

## Diameters

6" - 8".

## Listings

UL Listed to UL 103HT (MH7399).



# Product List

## DuraPlus

DuraPlus is designed to stay cool on the outside, to provide a hot draft on the inside, to boost stove efficiency, and to provide for a fire-safe design that protects both the chimney and the building. This triple-wall chimney features two insulating layers (ceramic blanket, plus air space). The ceramic blanket insulation is held securely in position, eliminating hot spots common with loose-fill type insulations. In the event of a creosote fire, the compressible blanket insulation permits the chimney liner to expand outwardly in a radial direction.

Designed for normal, continuous operation at 1000° F flue gas temperatures, DuraPlus is subjected to rigorous and stringent HT requirements of the UL standard, including one hour at 1400° F, plus three ten minute chimney fire tests at 2100° F.

	<b>DuraPlus Basic Kit</b> Kit includes: DVL/DuraBlack Chimney Adapter, Snap-Lock Adapter, 11" Square Ceiling Support Box with Trim, Adjustable Flashing 0/12-6/12, Chimney Cap, Storm Collar, and Attic Insulation Shield. Only available in 6" diameter. Pipe not included. Can be used for flat or vaulted ceiling installations. Use for typical through-the-roof installations.
	<b>DuraPlus Manufactured Home Kit</b> Kit includes: DVL/DuraBlack Adapter, 24" Square Ceiling Support Box with Trim, Adjustable Flashing 0/12-6/12, Chimney Cap, Storm Collar, and (2) 24" DuraPlus Chimney Pipe (galvanized). Only available in 6" diameter. Can be used for cathedral ceiling installations. Use for manufactured home through-the-roof installations.
	<b>DuraPlus Through-The-Wall Kit</b> Kit includes: DVL/DuraBlack Chimney Adapter, Snap-Lock Adapter w/ Trim, 9" DuraPlus Chimney Pipe (galvanized), Wall Thimble, Tee w/ Cap, (2) Wall Strap, Tee Support Bracket, and Chimney Cap. Only available in 6" diameter. Use for through-the-wall installations.
	<b>Chimney Pipe</b> 6" to 8" diameters. Stainless steel inner walls. Outer-casing in galvalume or stainless steel.
	<b>Elbow Kit</b> Kit includes: 2 Elbows and 1 Elbow Strap. 15° or 30° elbows swivel 360° at base.
	<b>Elbow Strap</b> Use to prevent excessive weight on the elbows by supporting the weight of the chimney. Required to be installed between two elbows in offset installations.
	<b>Round Ceiling Support</b> Supports chimney pipe and provides a positive connection between support box and chimney with a built-in twist-lock. Supports up to 35' of DuraPlus Chimney. Includes trim collar.
	<b>Square Ceiling Support Box</b> Supports up to 35 ft. of chimney. Use with flat, vaulted or cathedral ceilings; in 11", 24" or 36" lengths. Includes trim collar.

	<b>Flat Ceiling Support Box</b> Supports chimney pipe and provides a positive connection between support box and chimney with a built-in twist-lock. Designed for installation in flat ceilings only. Supports up to 35' of DuraPlus chimney pipe.
	<b>Wall Thimble</b> For passing chimney through a wall. Adjusts from a minimum of 4 3/4" to a maximum of 7 3/4" wall thickness, and fits between standard wall studs. To accommodate thicker walls, the telescoping pieces can be extended up to 16" with a field-fabricated extension installed.
	<b>Tee w/ Cap</b> For through-the-wall installations. The tee clean-out cap is removable for easy chimney cleaning or inspection.
	<b>Tee Support Bracket</b> Use to support the Tee; suspended from a wall. Supports up to 35' of DuraPlus Chimney. Starter Section built in.
	<b>Adjustable Wall Strap</b> Use in interior or exterior installations to support and to stabilize the chimney while assuring a 2" clearance. Wall straps are required every 4' on exterior of building. Adjusts 2"-6" from wall.
	<b>Wall Strap</b> Use in interior or exterior installations to support and to stabilize the chimney while assuring a 2" clearance. Wall straps are required every 4' on exterior of building only.
	<b>Base Plate</b> Use to adapt on a zero-clearance fireplace when using DuraPlus directly off the unit. Starter Section built in.
	<b>Transition Anchor Plate</b> Provides easy installation of DuraLiner to DuraPlus chimney when used with a slip connector and hanger.
	<b>Starter Section</b> Use only when converting from DuraLiner to DuraPlus and the DuraPlus Chimney is going to be enclosed in a chase.
	<b>Firestop Radiation Shield</b> Use in ceiling/floor penetrations when a ceiling support is not used. Not required when passing through the roof. Fits on underside of ceiling and adjusts to cover framing.

	<b>Attic Insulation Shield</b> Required for installations that pass through an attic to prevent insulation and debris from accumulating near the chimney. Fits over Firestop Radiation Shield or a support box.
	<b>Close Clearance Shield</b> Use in installations where a 7" or 8" DuraVent chimney system passes through a roof opening with less than the normal 2" minimum clearance to roof trusses or rafters.
	<b>Roof Flashings</b> Use to weather proof the penetration of chimney pipe through the roof. Storm Collar required. Select roof flashing based on pitch of roof. Also available in dead soft aluminum.
	<b>Storm Collar</b> Required with DuraPlus flashing to create a weatherproof penetration through the roof deck.
	<b>Extended Roof Bracket</b> Use to support the chimney when it extends more than 4' above the roof. Provides stability to chimney against wind and snow.
	<b>Chimney Cap</b> Required where chimney pipe terminates above the roof line. Removable screws allow for cleaning of the chimney and spark arrester screen. Made of stainless steel.
	<b>Snow Splitter</b> Use to divert snow around chimney, vent, and roof flashing. Constructed of paintable galvanized material.

## What Makes Us Different From The Rest?

Triple-wall chimney for ultimate performance and safety

Two insulating layers (ceramic blanket plus air space) keeps the exterior cool, while ensuring high flue gas temperatures for optimum draft performance

