

## Installation Instructions



Flexible aluminum relining system for relining masonry chimneys for natural gas or liquid propane category I, draft hood equipped appliances, and appliances tested and listed to use Type B gas vent.

DURAFLEX<sup>®</sup> AL

**DuraVent<sup>®</sup>**

**A MAJOR CAUSE OF VENT RELATED FIRES IS FAILURE TO MAINTAIN REQUIRED CLEARANCES (AIR SPACES) TO COMBUSTIBLE MATERIALS. IT IS OF THE UTMOST IMPORTANCE THAT DURAFLEX AL BE INSTALLED ONLY IN ACCORDANCE WITH THESE INSTRUCTIONS.**

**NOTE:**

Read through all of these instructions before beginning your installation. Failure to install as described in this instruction will void the manufacturer's warranty, and may have an effect on your homeowner's insurance and UL listing status. Keep these instructions for future reference.

**INSTALLER INFORMATION**

Name: \_\_\_\_\_

Address: \_\_\_\_\_

\_\_\_\_\_

Phone: \_\_\_\_\_

Date Installed: \_\_ / \_\_ / \_\_\_\_

**Dear Customer, Installer, or End User:**

We welcome any comments regarding matters pertaining to our DuraVent products. Send any ideas, input or complaints and we'll make sure that someone responds directly back.

Send your emails to:

[customerservice@duravent.com](mailto:customerservice@duravent.com)

If you are searching for tech support or product information, please call us at 800-835-4429.

Or email us at:

[techsupport@duravent.com](mailto:techsupport@duravent.com)



LISTED  
MH14420

**Flexible aluminum relining system**

*For the most up-to-date installation instructions, see [www.duravent.com](http://www.duravent.com)*

**CONTENTS**

Application ..... 4  
Warning ..... 4  
Important ..... 4  
Installation Precautions ..... 4  
Sizing Requirements ..... 5  
Prior to Installation ..... 5  
Chimney Liner Selection ..... 5  
Flexible Liner Installation ..... 6  
Tee Installation Instructions ..... 7  
Relining Instructions for gas fireplace venting into existing chimney ..... 8  
Terminations ..... 9  
Type B Gas Vent Top Termination ..... 9  
Type B Gas Vent Liner System ..... 10  
Flex Extensions ..... 11  
Inspection and Maintenance ..... 11  
Cleaning Procedure ..... 11

DURAFLEX<sup>®</sup> AL

## APPLICATION

The DuraFlex AL Chimney Relining System is UL listed for relining masonry chimneys that are intended to be used for venting gas appliances and decorative gas fireplaces. These instructions cover installation from the appliance vent connector through the wall of the masonry chimney, or through the damper, up to the termination cap.

The DuraFlex AL Gas Relining System is for venting listed Category I draft hood-equipped or fan-assisted gas appliances, decorative gas fireplaces, or other gas appliances listed by a recognized listing agency, and approved for use with Type B Gas Vent. DuraFlex AL requires a minimum clearance of 0 inches air space between interior masonry and gas liner.

## WARNING

The DuraFlex Gas Relining System shall not be used for venting wood-burning appliances, combination gas/oil burning appliances, incinerators, conversion burners, or listed Category II, III, or IV gas appliances.

The Lining System does not, in any way, upgrade the existing chimney to make it suitable for applications requiring a vent or chimney of a higher temperature handling capability.

The DuraFlex AL Gas Relining System is for use in masonry chimneys only. It is important that B-Vents and Vent Connectors be installed to the DuraFlex system per DuraVent installation instructions.

## IMPORTANT

Read all instructions carefully before starting the installation. Failure to follow these instructions may cause a fire or other safety hazard, and will void the warranty. It is important to follow the appliance manufacturer's installation instructions and to check the label on the appliance to confirm the appliance category and any restrictions or limitations. Consult the appliance manufacturer's instructions to determine the maximum run allowed for venting.

## INSTALLATION PRECAUTIONS

The DuraVent DuraFlex is an engineered product that has been designed and tested for use as specified above. The DuraVent warranty will be voided, and serious fire, health, or other safety hazards may result from any of the following actions:

- Installation of any damaged component.
- Unauthorized modification of any DuraVent product.
- Installation of any component part not manufactured or approved by DuraVent.
- Installation other than as instructed by DuraVent and the appliance manufacturer.

Consult your local building codes before beginning the installation.

**CAUTION!** Make sure you have the proper equipment for the job, including adequate safety protection for working at elevated heights. Always wear gloves and safety glasses when handling sheet metal parts.

## SIZING REQUIREMENTS

Proper sizing of the relining system to the appliance(s) is very important. For complete sizing instructions, refer to the National Fuel Gas Code, the International Fuel Gas Code, the appliance manufacturer's installation instructions, or the DuraVent Sizing Handbook. Failure to properly size the venting system may result in draft hood spillage, back pressure, or corrosive condensation in the relining system.

As an alternate method (for draft hood-equipped appliances and decorative gas fireplaces only) the venting system may be sized to the outlet of the appliance. For two or more draft hood-equipped appliances, the effective area of the vent shall not be less than the area of the largest appliance, plus 50% of the areas of additional draft hood outlets. For fan-assisted gas appliances, the vent system must be sized using the sizing instructions and tables referenced above.

## PRIOR TO INSTALLATION

Before installing the Chimney Liner System, check with local authorities to determine if a permit is necessary and check applicable building code to ensure the existing chimney meets all requirements.

The chimney passageway should be examined to confirm that it is clear and free of cracked, loose, or missing bricks, mortar, or other materials that could inhibit correct installation. The chimney passageway must be cleaned if it has been previously used for venting solid or liquid-burning appliances or fireplaces.

## CHIMNEY LINER SELECTION

The basic DuraFlex AL Chimney Liner System consists of a continuous flexible liner from the top of the appliance to the top of the chimney (*Figure 1*). This system is easy to install, even in masonry chimneys that are constructed with an offset. This single-wall flexible system is intended for warm interior masonry chimneys enclosed within the building on all four sides, and only exposed to cold outdoor temperatures above the roof line.

In cold climates, it is recommended to switch to double-wall, air insulated Type B Gas Vent near the upper portion of the chimney (*Figure 2*). At the top of the chimney, the flue gas has lost much of its heat and is susceptible to corrosive condensation and poor draft. This is particularly true with fan-assisted gas appliances.

In the event that the existing masonry chimney is relatively short in height, the draft may be too weak for proper performance of the appliance and

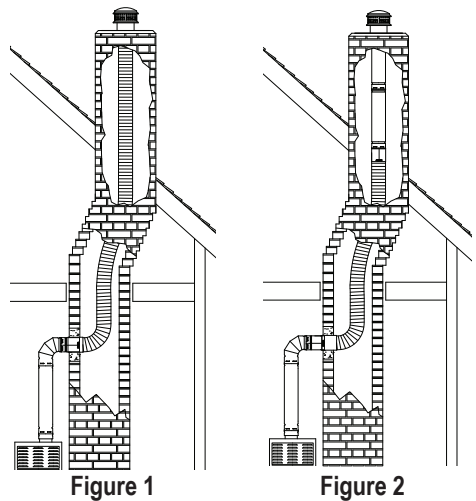

Figure 1

Figure 2

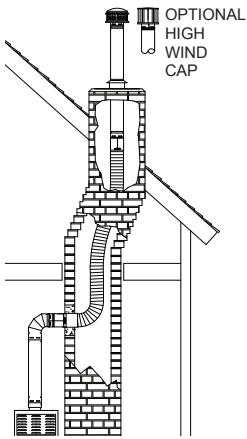

Figure 3

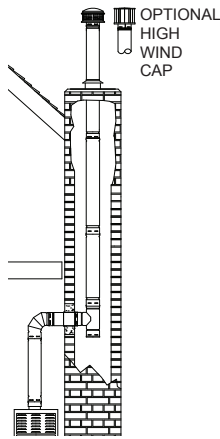

Figure 4

venting system. By switching to Type B Gas Vent at the top of the chimney, the installer has the option of extending the height of the venting system (*Figure 3*).

For exterior masonry chimneys, typically exposed on one or more sides to cold outdoor temperatures, a 100% Type B Gas Vent Chimney Liner system is preferable (*Figure 4*).

In the event that the exterior masonry chimney is constructed with an offset, single-wall flex will be necessary below the offset, with Type B Gas Vent above the offset.

If you decide to install the Flexible Liner, the DuraFlex AL kit is available for convenience. The kit includes: a DuraFlex AL Cap, Top Plate, Mortar Sleeve, and a 15', 25', or 35' length of DuraFlex liner. Any additional parts will need to be ordered separately.

## FLEXIBLE LINER INSTALLATION

The basic flexible liner installation procedure for gas appliances such as Category I furnaces, water heaters, and boilers is as follows:

**Step 1.** Measure and record the interior dimensions of the masonry chimney and the height of the chimney from the top to the penetration in the masonry through which the liner will pass.

**Step 2.** After locating where the appliance flue connection will be made in the chimney wall, break out sufficient masonry to form an opening large enough for the Mortar Sleeve or Flex Liner to pass through easily. If a Tee application is necessary, a larger hole may be required (See Tee Installation Section).

**Step 3.** Extending the Flex Liner from its compressed length requires two people. Extend half of the length at a time.

- Start by facing each other at the mid-point in the liner (*Figure 5*).
- Hold the liner firmly while one person walks backwards, stretching sections of the liner as they back up.
- It is important that as the liner stretches, it is allowed to rotate naturally. This will help ensure the liner can stretch to its maximum length without being damaged. Do not overstretch the liner beyond its specified length as this can damage the liner.
- Repeat these steps on the other half of the liner.

**Step 4.** Secure a rope to the Flex Puller and attach the Flex Puller to DuraFlex

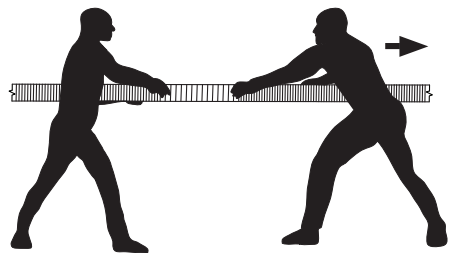

Figure 5

Liner (**Figure 6**). One person should feed the Liner through the chimney, and the other person should pull the Liner from the bottom, using the rope to guide the Liner through to the chimney bottom.

**Step 5.** Carefully form a 90° angle ensuring the liner does not get kinked or dented then bring the DuraFlex liner through the hole in the chimney wall.

**Step 6.** Slide the Mortar Sleeve over the DuraFlex Liner until the Mortar Sleeve is flush with the wall of the chimney (**Figure 7**). Once the Mortar Sleeve is in place, the space between the sleeve and the masonry may be filled with grout.

**Step 7.** The Flex Liner should extend at least 2 inches beyond the flange on the Mortar Sleeve. If Type B Gas Vent or the DuraConnect Flexible Vent Connector is to be used between the appliance and the chimney liner, slide

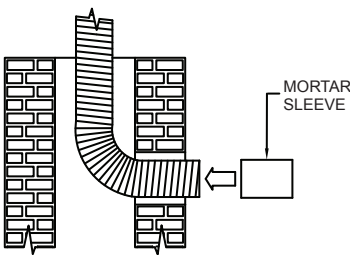
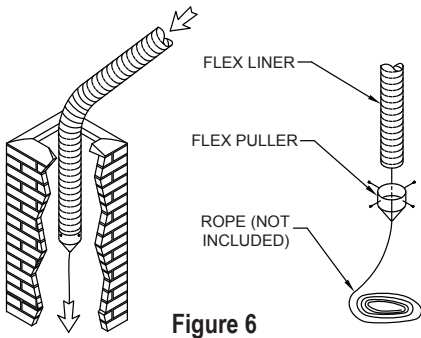

the Flex Coupling or B-Vent Female Adaptor over the Flex Pipe and secure with either a nut & bolt or sheet metal screws (**Figure 8**). If a single-wall galvanized steel Vent Connector is to be used between the appliance and the chimney liner, attach the Flex Coupling or B-Vent Female Adaptor to the Flex Liner. Crimp the end of the Vent Connector and attach to the Flex Coupling or B-Vent Female Adaptor.

## TEE INSTALLATION INSTRUCTIONS

**Step 1.** If a Tee application is required and the masonry chimney has no offsets, attach the body of the Tee to the Flex by tightening the fast connect band (**Figure 9**). Attach the other end of

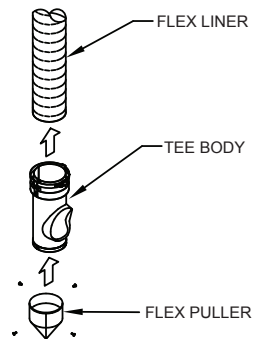
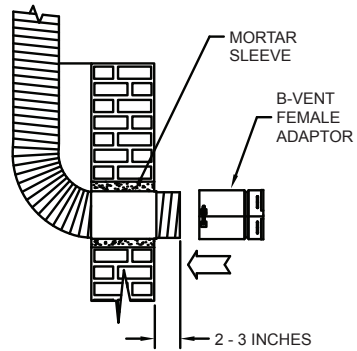

the Tee to the Flex Puller and proceed as described in **Step 4** of the previous section.

**Step 2.** If the masonry has an offset, pull the Flex down as described in **Step 4** of the previous section so the end is even with the opening in the chimney wall. Disconnect the Flex Puller. Attach the Tee Cap to the bottom of the Tee (if not already attached), remove the Tee Branch, and attach the Tee to the Flex Liner (**Figure 10**).

**Step 3.** When the Tee is in its final location, attach the Tee Branch to the main body of the Tee (**Figure 11**). Align the locking slots on the Tee Branch with the studs on the Tee then slide it into the Tee. Rotate the Tee Branch clockwise to snap it into a locked position.

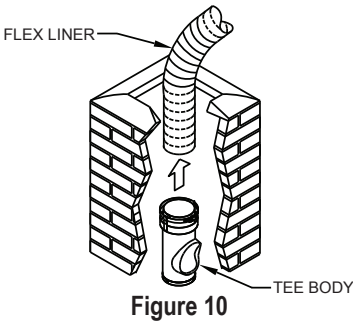

Figure 10

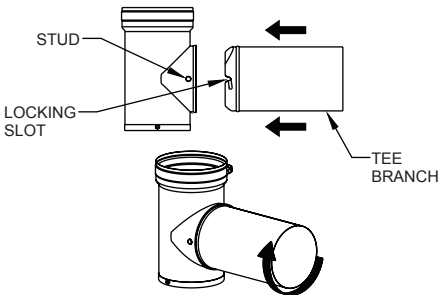

Figure 11

**Step 4.** After the Tee is installed, Type B Gas Vent or DuraConnect Flexible Vent Connector can be attached directly to the Tee Branch using a minimum of three screws. Slide the Mortar Sleeve over the connector and branch and fill in around the Mortar Sleeve with grout, keeping both the Tee centered in the masonry chimney and the flange of the Mortar Sleeve even with the wall of the chimney.

**Step 5.** Complete the Vent Connector attachment to the gas appliance.

## RELINING INSTRUCTIONS FOR A GAS FIREPLACE VENTING INTO AN EXISTING MASONRY FIREPLACE AND CHIMNEY

**Step 1.** Measure and record the interior dimensions of the masonry chimney and the height from the top of the chimney to the top of the fireplace.

**Step 2.** Extend the Flex Liner from its compressed length to its normal length by pulling at the ends. Do not extend flex liner beyond its normal length. Attempting to do so may result in damage to the liner.

**Step 3.** Secure a rope to the Flex Puller and attach the Flex Puller to the DuraFlex Liner. One person should feed the liner through the chimney from the top, while another should pull the liner from the bottom (**Figure 6**).

Two people are required to ensure the aluminum flex liner is not torn during installation.

**Step 4.** After the Flex Liner is pulled through the damper area, attach the Flex Coupling to the end of the Flex with sheet metal screws, then connect it directly to the flue outlet on top of the gas fireplace (**Figure 12**).



## TERMINATIONS

Terminations with bird screens are required in some areas but are susceptible to blockage from freezing moisture in areas with low ambient temperatures. Consult the authority having jurisdiction to determine if a bird screen is required.

**Step 1.** When terminating your Flex installation, ensure the Flex protrudes 4-5 inches over the top of the masonry chimney (*Figure 13*). If necessary, trim the base of the Top Plate to fit the masonry chimney.

**Step 2.** Slide the Top Plate over the Flex and seal the Top Plate to the masonry chimney using a bead of non-hardening sealant around the top of the chimney to prevent moisture intrusion (*Figure 13*).

**Step 3.** Slide the DuraFlex AL Cap onto

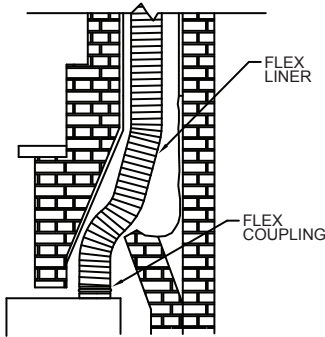

Figure 12

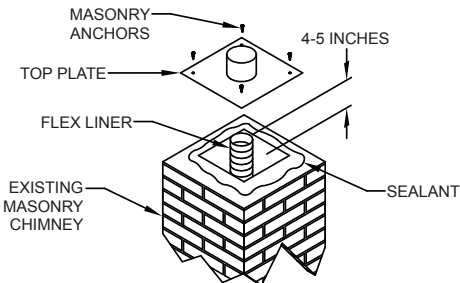

Figure 13

the flex and attach it by tightening the fast connect band (*Figure 14*). Push the Cap down until it rests on the Top Plate's collar. The Cap serves as the top support for the liner system, and is UL Listed to support the Flex. See *Table 1* for the maximum length of flex the Cap can support.

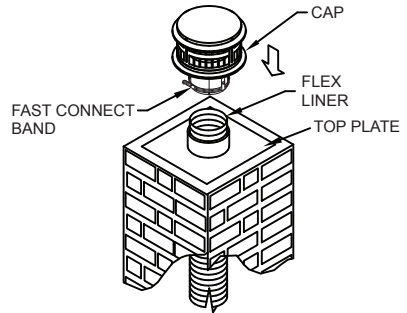

Figure 14

Table 1: Length of Liner Supported

Flex Diameter	Feet Supported
3"	120 ft.
4"	100 ft.
5"	70 ft.
5 1/2"	70 ft.
6"	60 ft.
7"	50 ft.
8"	50 ft.

## TYPE B GAS VENT TOP TERMINATION

The installation procedure for use of insulated Type B Gas Vent near the top of the masonry chimney, or for extending the height of the venting system above the masonry chimney is as follows:

**Step 1.** You will need a B-Vent Cap (standard or high wind), Storm Collar, Top Plate, Male B-Vent Flex Adaptor, and a length of B-Vent Pipe to extend

the Cap if needed (**Figures 15 & 16**).

**Step 2.** Attach the male B-Vent Flex Adaptor to the flex with the locking lug and four sheet metal screws, as shown in **Figure 15**.

**Step 3.** Attach a suitable length of double-wall Type B Gas Vent pipe to the male B-Vent Flex Adaptor. After sealing the Top Plate to the masonry chimney using the non-hardening sealant, slide the B-Vent Storm Collar over the length of B-Vent pipe, until the proper length of pipe extends above the chimney. Always have a minimum of 12 inches of B-Vent pipe below the Top Plate for stability. It is preferable

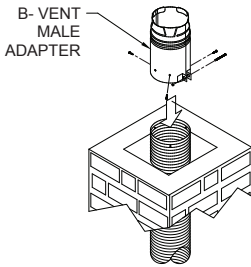

**Figure 15**

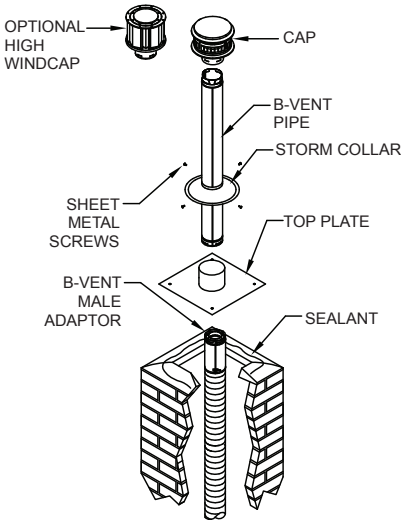

**Figure 16**

to extend the B-Vent pipe down within the masonry chimney to the roof line level to keep the flue gas hot in the exposed portion of the masonry chimney. Attach the Storm Collar to the B-Vent pipe with (4) 3/8-inch long sheet metal screws equally spaced at 90° (**Figure 16**). The Storm Collar rests on the Top Plate and serves as the top support for the liner system. It is UL Listed to support the Flex or B-Vent Liner. Refer to **Table 1** to determine the maximum length supported.

**Step 4.** Seal the Storm Collar to the Top Plate and twist-lock the B-Vent top to the B-Vent pipe. As an alternative to the standard cap, you may want to install a B-Vent High-Wind Top in areas where excess wind may be a concern (**Figures 16 & 17**).

**Step 5.** For improved draft, the vent may be extended in height above the top of the masonry chimney by simply adding additional lengths of B-Vent Pipe. If the vent is more than 3 feet above the top of the chimney, secure it with a locally fabricated brace, as shown in **Figure 17**.

## TYPE B GAS VENT LINER SYSTEM

For exterior chimneys in cold climates, an air insulated, double-wall Type B Gas Vent Liner system is

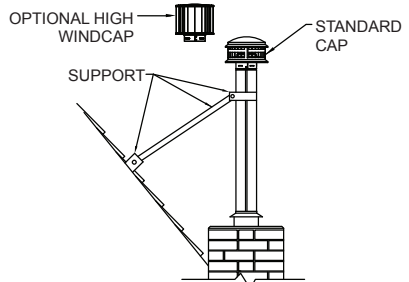

**Figure 17**

recommended, particularly for fan-assisted gas appliances, which have a greater tendency to produce corrosive condensation when flue gases are permitted to cool in the vent system. To install a 100% Type B Gas Vent Liner, use a Type B Gas Vent Termination and Pipe Lengths, in combination with a Type B Gas Vent Tee.

In the event that the exterior masonry chimney has an offset, it will be necessary to feed Flexible Liner down through the offset, with Type B Gas Vent to be used above the offset.

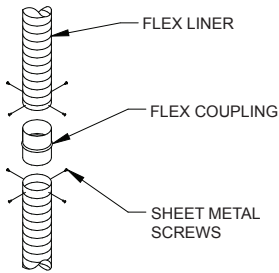

Figure 18

## FLEX EXTENSIONS

For tall chimney installations where more than one length of flex is required, additional Flex may be purchased in various lengths. Two lengths of Flex may be connected using the Flex Coupling (*Figure 18*).

Connect the DuraFlex AL sections to the ends of the Flex Coupling using four sheet metal screws per side.

## INSPECTION AND MAINTENANCE

A warning label is required near the appliance connection concerning the liner's limitations of use with specific fuels and appliances, including a reminder to check the rain cap for icing during low ambient temperatures. The label should also include the date of installation, the manufacturer's name,

the model number, and class of lining system.

Annual inspections are required to comply with the terms of the warranty. Excessive condensation and chimney fires can be prevented through proper appliance use and maintenance.

To properly inspect the liner, gain access from either the top or bottom of the chimney.

When examining from the bottom, remove the connector from the thimble or, if access is available, inspect through the clean-out cap of the Tee.

Use a mirror and flashlight or chimney inspection camera to examine the inside of the liner. When examining from the top, support the flex so it does not fall into the chimney, then remove the Rain Cap. Examine the inside as described previously, and determine if cleaning is necessary.

Should a fire occur within the Liner, notify the fire department immediately.

Fires are catastrophic events for any chimney. Before using the chimney after a fire, it must be inspected by a qualified person and cleaned or repaired as necessary.

## CLEANING PROCEDURE

Support the flex then remove the Vertical Cap, or if working from the bottom, remove the appliance connector or clean-out cap. Select appropriately sized polypropylene chimney brushes and flexible fiberglass extension rods. Run the brush up and down inside the liner until any deposits or debris are removed. Reinstall the Vertical Cap, connector pipe or Tee Cap.

## DURAVENT LIMITED LIFETIME WARRANTY

M&G DuraVent, Inc. ("DuraVent") provides this limited lifetime warranty for all of its products with the exception of Ventinox® (lifetime), and PolyPro® (ten years). Subject to the limitations set forth below, DuraVent warrants that its products will be free from defects in material or manufacturing, if properly installed, maintained and used. DuraVent products are fully warranted if installed only by a professional installer. This Warranty is transferable from the original homeowner to the buyer of the home. This warranty does not cover normal wear and tear, smoke damage or damage caused by chimney fires, acts of God, or any product that was: (1) purchased other than from an authorized DuraVent dealer, retailer or distributor; (2) modified or altered; (3) improperly serviced, inspected or cleaned; or (4) subject to negligence or any use not in accordance with the installation instructions included with the product as determined by DuraVent. Installation instructions are available online at [www.duravent.com](http://www.duravent.com) under Support/Literature and through our Customer Service Department 800-835-4429 or [customerservice@duravent.com](mailto:customerservice@duravent.com). This limited lifetime warranty applies only to parts manufactured by DuraVent.

DuraVent provides the following warranties for its products: One Hundred Percent (100%) MSRP 15 years from the date of purchase, and Fifty Percent (50%) thereafter, except for the following limitations on: all Termination Caps and DuraBlack® are warranted at One Hundred Percent (100%) for five years.

All warranty obligations of DuraVent shall be limited to repair or replacement of the defective product pursuant to the terms and conditions applicable to each product line. These remedies shall constitute DuraVent's sole obligation and sole remedy under this warranty. This warranty provides no cash surrender value. The terms and conditions of this warranty may not be modified, altered or waived by any action, inaction or representation, whether oral or in writing, except upon the express, written authority of an executive officer of DuraVent.

Corn, bio-fuels, driftwood or other wood containing salt, preservative-treated lumber, plastic and household trash or garbage, or wood pellets containing such materials must not be burned in the appliance or fireplace. In case of a chimney fire, the chimney must be inspected and approved by a certified Chimney Sweep before reuse. After each annual inspection, maintenance, and cleaning, the certified Chimney Sweep must fill out and date the appropriate section of the warranty card provided with the chimney liner.

LIMITATIONS ON INTERNET SALES: Notwithstanding any other terms or conditions of this Limited Lifetime Warranty, DuraVent provides no warranty for the following specific products if such products are not installed by a qualified professional installer: DuraTech®, DuraPlus HTC®, DuraTech® Premium, DuraChimney® II, PelletVent Pro®, DirectVent Pro®, FasNSeal®, FasNSeal® W2, FasNSeal® Flex, and PolyPro®, and DuraVent's relining products including DuraLiner®, DuraFlex® (SW, Pro, 316, 304), and Ventinox®. For purposes of this warranty, a trained professional installer is defined as one of the following: licensed contractors with prior chimney installation experience, CSIA Certified Chimney Sweeps, NFI Certified Specialists, or WETT Certified Professionals.

DuraVent must be notified and given the opportunity to inspect defective product prior to replacement under the terms of this limited lifetime warranty. All warranty claims must be submitted with proof of purchase. Labor and installation costs are not covered under this warranty. To obtain warranty service contact: DuraVent Warranty Service, 877 Cotting Ct., Vacaville CA 95688, or call 800-835-4429.

WHERE LAWFUL, DURAVENT DISCLAIMS ALL OTHER WARRANTIES, INCLUDING BUT NOT LIMITED TO IMPLIED WARRANTIES OF MERCHANTABILITY AND FITNESS FOR A PARTICULAR PURPOSE. IN NO EVENT WILL DURAVENT BE LIABLE FOR INCIDENTAL, CONSEQUENTIAL, PUNITIVE OR SPECIAL DAMAGES OR DIRECT OR INDIRECT LOSS OF ANY KIND, INCLUDING BUT NOT LIMITED TO PROPERTY DAMAGE AND PERSONAL INJURY. DURAVENT'S ENTIRE LIABILITY IS LIMITED TO THE PURCHASE PRICE OF THIS PRODUCT. SOME STATES DO NOT ALLOW LIMITATIONS ON IMPLIED WARRANTIES, OR THE EXCLUSION OR LIMITATION OF INCIDENTAL OR CONSEQUENTIAL DAMAGES, SO THE ABOVE LIMITATIONS AND EXCLUSIONS MAY NOT APPLY TO YOU. THIS LIMITED WARRANTY GIVES YOU SPECIFIC LEGAL RIGHTS, AND YOU MAY ALSO HAVE OTHER RIGHTS THAT VARY FROM STATE TO STATE.

For the most up-to-date installation instructions, see [www.duravent.com](http://www.duravent.com)

REV 05.03.18

Manufactured in Vacaville CA and Albany NY

# DuraVent®

**Customer Service Support: 800-835-4429 • 707-446-4740 FAX • [www.duravent.com](http://www.duravent.com)**

DuraFlex is a registered trademark of DuraVent, Inc.  
All rights reserved, Made in the USA. © 2012, 2017

L219\_820003159\_Install Instructions\_DuraFlex AL\_05-03-18\_V2